

INFORMACIÓN TÉCNICA

SALA	AFORO	TAMAÑO PANTALLA (m ²)	DISTANCIA PANTALLA A CABINA (m)	DISTANCIA PANTALLA A PRIMERA FILA (m)
SALA 1	214  4	14x6	22,5	6,5
SALA 2	214  4	14x6	22,5	6,5
SALA 3	214  4	14x6	22,5	6,5
SALA 4	214  4	14x6	22,5	6,5
SALA 5	328  7	17x7	28,5	7,5
SALA 6	330  7	17x7	28,5	7,5
SALA 7	328  7	17x7	28,5	7,5
SALA 8	328  7	17x7	28,5	7,5
SALA 9	408  9	20x9	34,5	11,5
SALA 10	408  9	20x9	34,5	11,5
SALA 11	405  9	20x9	34,5	11,5
SALA 12	408  9	20x9	34,5	11,5
SALA 13	214  4	14x6	22,5	6,5
SALA 14	214  4	14x6	22,5	6,5
SALA 15	214  4	14x6	22,5	6,5
SALA 16	214  4	14x6	22,5	6,5
SALA 17	330  7	17x7	28,5	7,5
SALA 18	328  7	17x7	28,5	7,5
SALA 19	328  7	17x7	28,5	7,5
SALA 20	330  7	17x7	28,5	7,5
SALA 21	408  9	20x9	34,5	11,5
SALA 22	408  9	20x9	34,5	11,5
SALA 23	706  15	25x10	40,5	12
SALA 24	703  15	25x10	40,5	12

TAMAÑO Y CAPACIDAD ESPACIOS RECEPCIÓN



ESPACIO	DIMENSIONES (m ²)	PERSONAS DE PIE	PERSONAS SENTADAS
FERRANDIS	325	700	400
MARE NOSTRUM	275	425	200

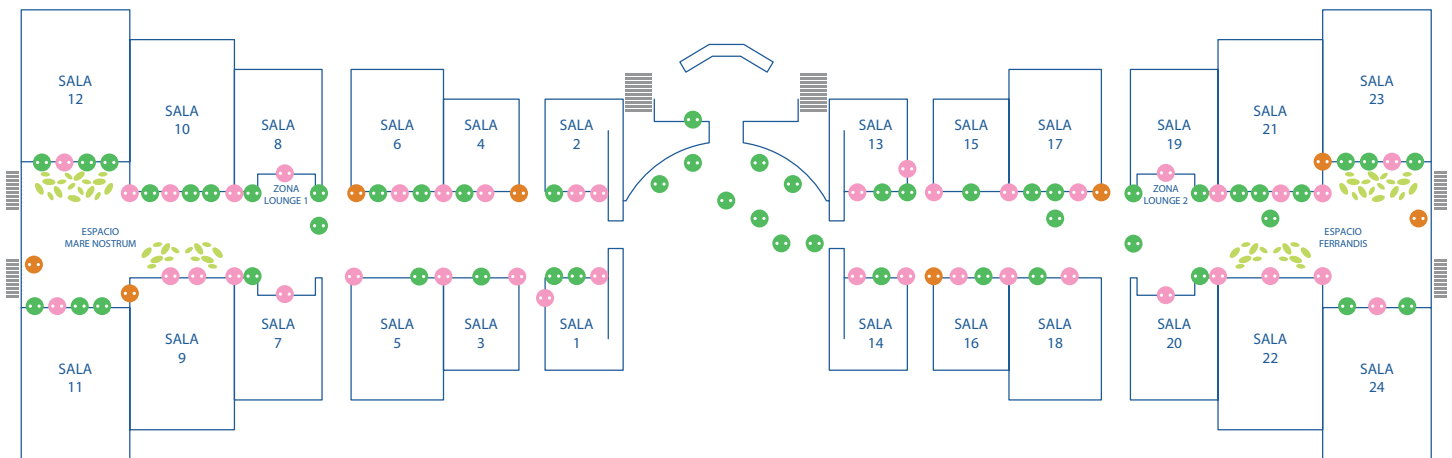

INFORMACIÓN TÉCNICA BÁSICA PARA MONTAJES





PLANTA CINES

-  ● 4 tomas de 380 Vol trifásicas
-  ● 16 tomas 220 Vol monofásica con c.e. de sala
-  ● 52 tomas 220 Vol monofásicas



PLANTA CABINA DE PROYECCIÓN

-  ● 4 tomas de 380 Vol trifásica
-  ● 24 tomas 220 Vol monofásica con c.e. de sala



PLANO LOUNGE 1

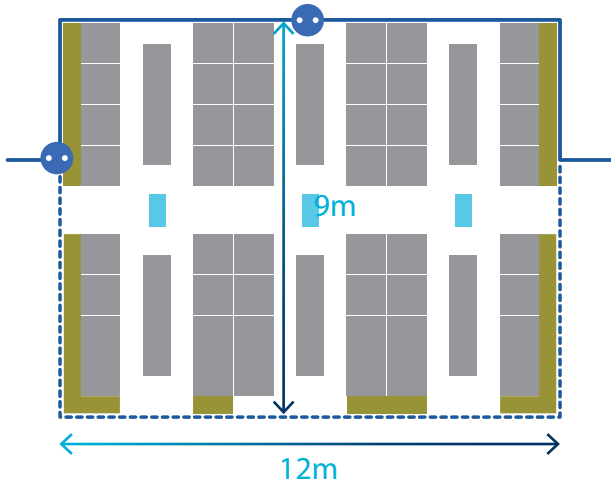

107m²

PLANO LOUNGE 2

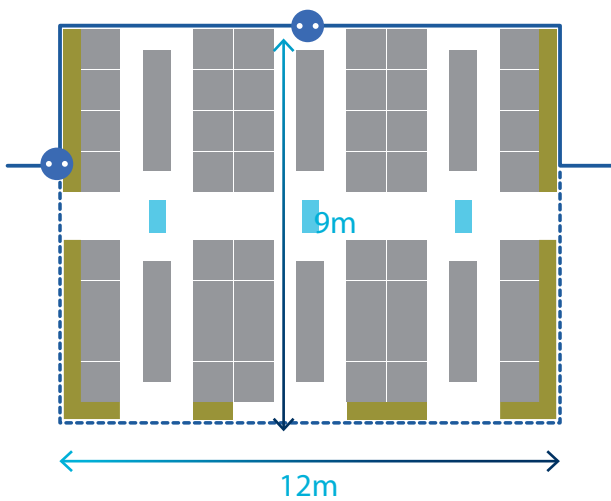

107m²

● Enchufe ■ Monitor Samsung 40"



PLANO MARE NOSTRUM

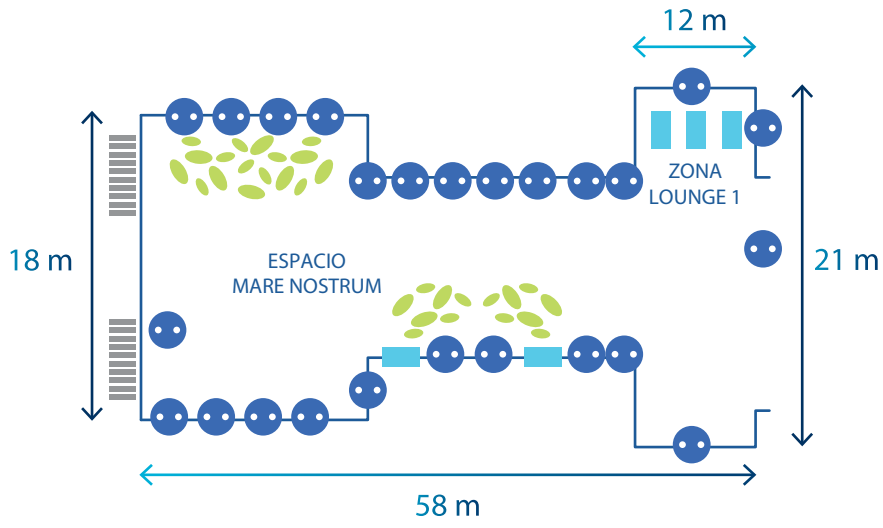

 1.045m²

PLANO FERRANDIS

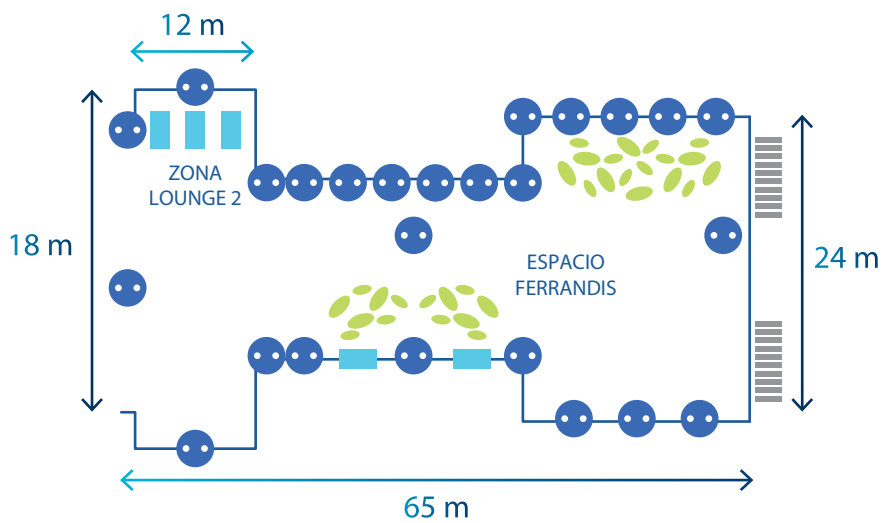

 1.265m²

 Enchufe  Monitor Samsung 40"